

STRONGWELL®

DURACRATE®

MOLDED FIBERGLASS GRATING

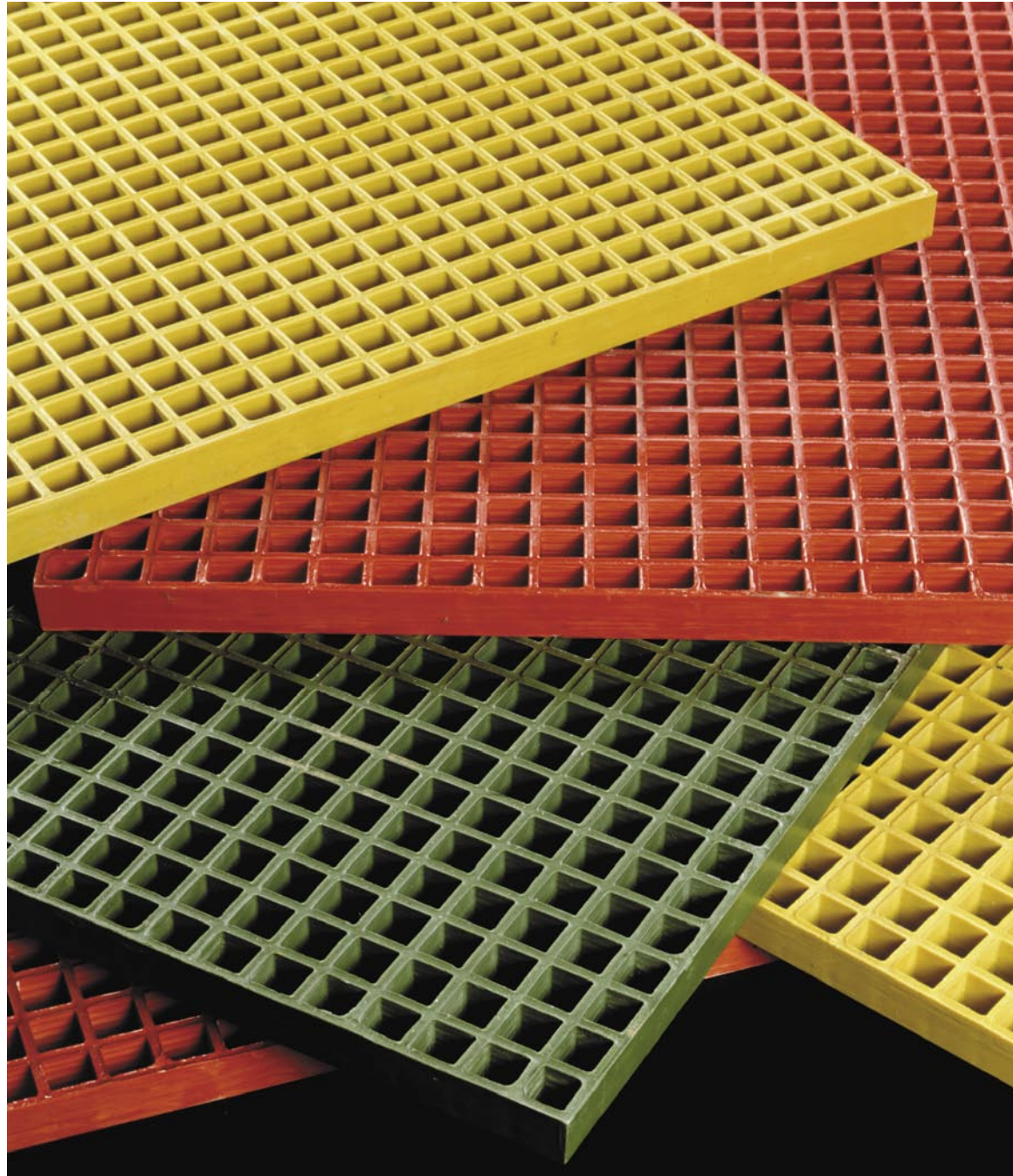

Molded Fiberglass Grating

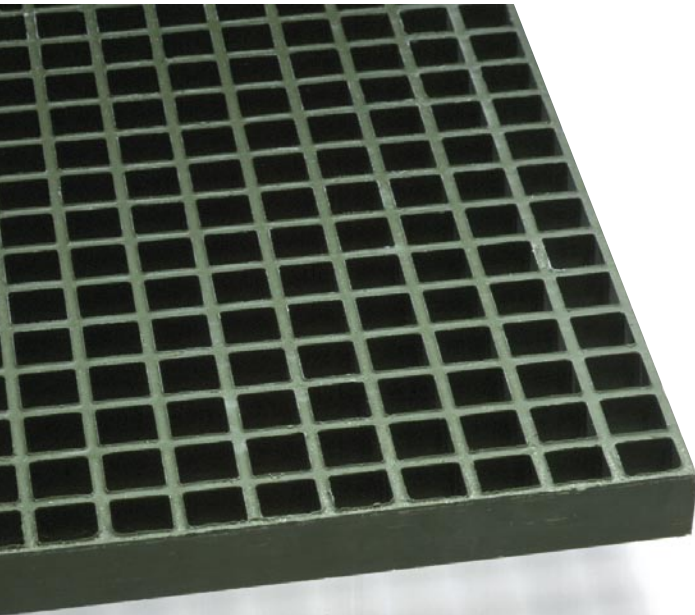

What is DURAGRATE®?

DURAGRATE® molded fiberglass grating is a strong mesh grating panel that is the chemical resistant flooring choice for many industrial applications. DURAGRATE® panels are molded in one piece and feature a concave non-slip walking surface. The cost-effective panels allow for efficient on-site cutting to minimize grating waste and load bearing bars in both directions allow for use without continuous side support.

DURAGRATE® molded fiberglass grating is significantly lighter in weight than metallic gratings and the high resin content (65%) provides long, virtually maintenance-free performance. A higher safety factor is achieved by designing in a higher glass content at the bottom of the grating for greater tensile strength.

DURAGRATE® molded fiberglass grating is:

- Corrosion Resistant
- Fire Retardant
- Low in Maintenance
- Lightweight
- Easy To Install
- Uniform in Appearance
- Easy To Fabricate
- Impact Resistant
- Low in Conductivity
- Bidirectional Load Bearing
- Cost Effective

Materials of Construction

DURAGRATE® molded fiberglass grating is composed of fiberglass rovings combined with a choice of five thermosetting resin systems. All of the resins contain a protective UV inhibitor.

Standard DURAGRATE® grating has a concave profile on the upper surface for skid resistance. Grit tops are available upon request.



The Exide Battery Plant in Manchester, Iowa installed corrosion resistant DURAGRATE® around its tanks of sulfuric acid.

Standard Resin Systems Available*

Resin Code	Description	Resin Base	Corrosion Resistance	Flame Spread Rating**	NSF-61 Approval
VE	Chemical Proof Fire Retardant	Vinyl Ester	Excellent	Class 1 25 or less	
NVE	Chemical Proof Fire Retardant	Vinyl Ester	Excellent	Class 1 25 or less	Hot & Cold
XVE	Chemical Proof Fire Retardant	Vinyl Ester	Excellent	Class 1 10 or less	
PP	Industrial Grade Fire Retardant	Isophthalic	Very Good	Class 1 25 or less	
NPP	Industrial Grade Fire Retardant	Isophthalic	Very Good	Class 1 25 or less	Hot & Cold
GP	Architectural Grade Fire Retardant	Orthophthalic	Good	Class 1 25 or less	
FF	Food Grade Fire Retardant	Isophthalic	Very Good	Class 2 30 or less	

*Strongwell's Standard Colors are Dark Gray, Green, Yellow, Orange and Light Gray. Contact Customer Service for Resin System and Color Requirements. Custom Colors are Available upon Request.

** Flame Spread Rating per ASTM E-84 Tunnel Test

Technical Data

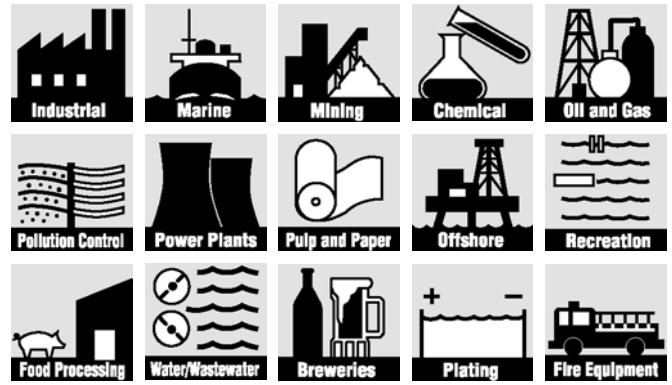

Shapes, Sizes and Availability

Typical DURAGRATE® Panels		
THICKNESS	MESH PATTERN	PANEL SIZES
1"	1-1/2" Square	3' x 10', 4' x 8', 4' x 12'
1"	1" x 4" Rectangular	3' x 10', 4' x 12'
1-1/2"	3/4" x 3/4" Mini-Grid™	4' x 12'
1-1/2"	1-1/2" x 6" Rectangular	4' x 12'
1-1/2"	1-1/2" Square	3' x 10', 4' x 8', 4' x 12', 5' x 10'
2"	2" Square	4' x 12'

NOTE: All panel sizes available in VE, XVE, PP, GP or FF resin systems. NPP and NVE resin systems are available in most panel sizes. Custom panel sizes and resins available upon request.

How to Specify

The molded fiberglass grating shall be DURAGRATE® as supplied by Strongwell. Grating panels shall be (pick one from chart for thickness, mesh pattern, resin code) molded grid pattern. The grating shall be one-piece construction with the tops of the bearing bars and cross bars in the same plane. Color shall be (green) (orange) (yellow) (dark gray) (light gray). Surface shall be (concave top) (gritted).

Stair Treads

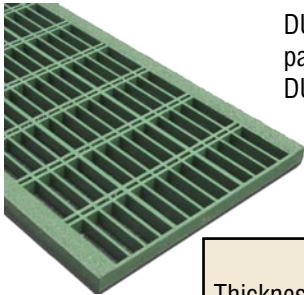

DURAGRATE® molded fiberglass stair treads are available in a 1-1/2" thick 1-1/2" x 6" rectangular mesh pattern. The standard panel size is 22-1/2" x 10'. Stair treads can be produced in any of the standard DURAGRATE® resin systems. The stair tread panel comes complete with anti-slip nosing.

DURAGRATE® Stair Tread

Thickness	Mesh	Panel Size	Maximum Span for 300 lbs. at Mid-Span		Panel Weight	Open Area
			1/8" or less deflection	1/4" or less deflection		
1-1/2"	1-1/2" x 6"	22-1/2" x 10'	31"	38"	60 lbs.	67%

Stair Tread Panel Cutting Diagram

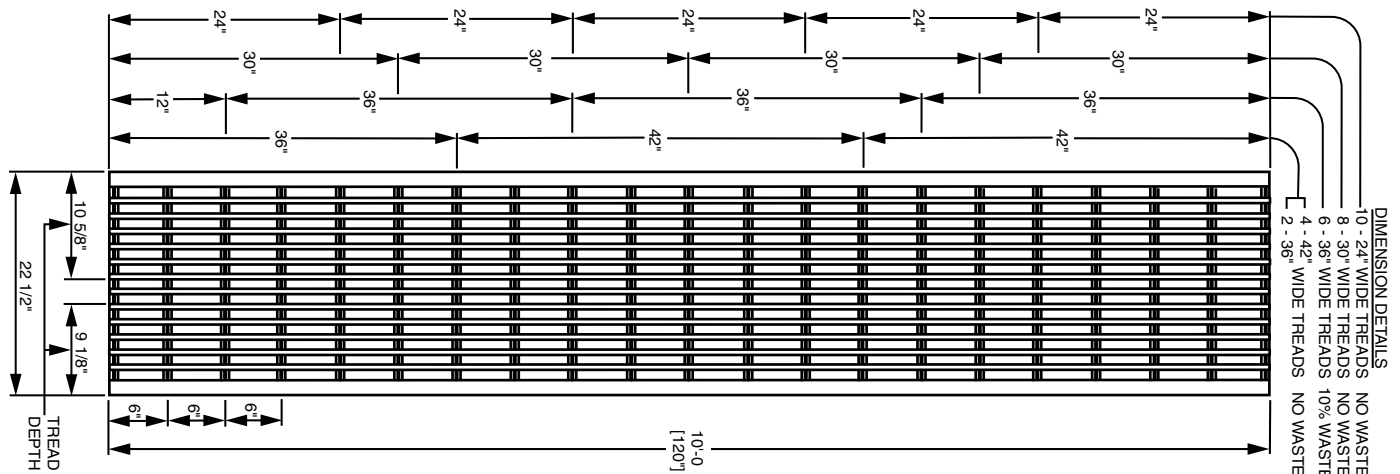

Accessories

Panel Installation

Type M Clips

For attaching grating to supports.

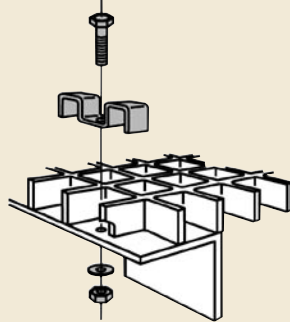

Type J Clips

For attaching grating to supports for moderate loads.

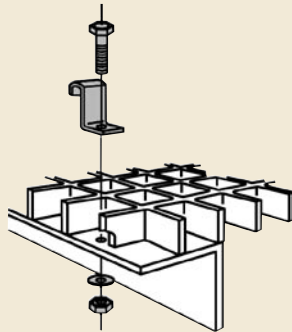

Type C Clips

For joining two unsupported edges if needed.

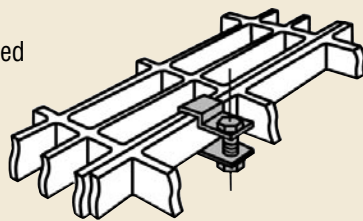

Sealing Kits

To maintain corrosion resistance and structural integrity, standard resin sealing kits are available to protect the exposed ends of cut panels and other components.

Solid Surface

DURAGRATE® is available with an integral cover bonded to the top surface with a slip resistant grit surface.



Elevated Floor System

Fixed and adjustable legs for molded grating are available to provide sturdy support for elevated flooring. Contact Strongwell with your exact requirements.

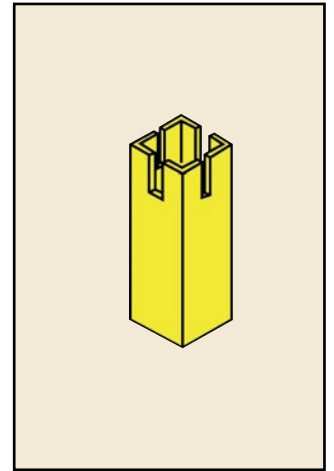
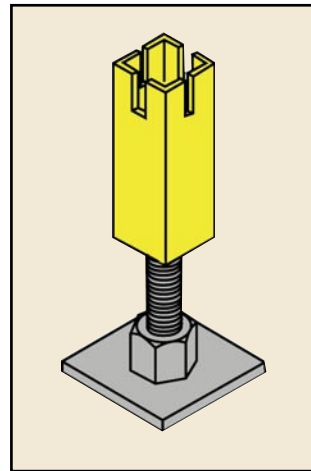

Curb Angle

Strongwell's pultruded fiberglass Curb Angle provides a strong, firm base for bearing bars. Standard Curb Angle is produced using a gray, fire retardant vinyl ester resin system and is available in three sizes.

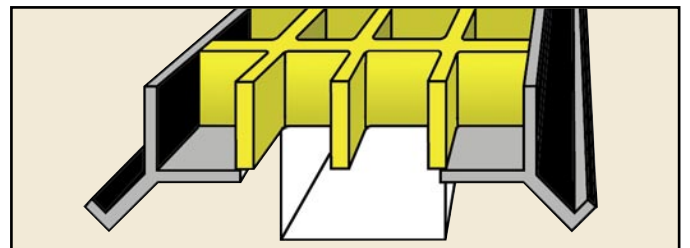

Load Tables

1" THICK 1-1/2" SQUARE MESH DURAGRATE®

A=1.71 in.²/ft. of width
 l=0.14 in.⁴/ft. of width
 S=0.29 in.³/ft. of width

1" bearing bars: Values per foot of width
 Open Space = 70%
 Approx. Weight = 2.6 lbs/sq. ft.

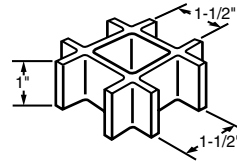

SPAN INCHES		LOAD								SAFE LOAD 5:1 SAFETY FACTOR	DEFLECTION	E x 10 ⁶ PSI
		50	100	150	200	250	300	400	500			
12	Δu	<0.010	<0.010	0.013	0.017	0.021	0.025	0.034	0.042	1360	0.115	1.90
	Δc	<0.010	0.014	0.020	0.027	0.034	0.041	0.054	0.068	680	0.092	
18	Δu	0.021	0.041	0.062	0.082	0.103	0.123	0.164	0.205	666	0.274	1.98
	Δc	0.022	0.044	0.066	0.088	0.110	0.131	0.175	0.219	500	0.219	
24	Δu	0.064	0.128	0.192	0.256	0.320	0.384	0.512	0.640	380	0.486	2.01
	Δc	0.051	0.102	0.154	0.205	0.256	0.307	0.409	0.512	380	0.389	
30	Δu	0.155	0.309	0.464	0.619					240	0.742	2.03
	Δc	0.099	0.198	0.297	0.396	0.495	0.594			300	0.594	
36	Δu	0.318	0.635							160	1.016	2.05
	Δc	0.169	0.339	0.508	0.677					240	0.813	

1" THICK 1" x 4" RECTANGULAR MESH DURAGRATE®

A=2.57 in.²/ft. of width
 l=0.22 in.⁴/ft. of width
 S=0.43 in.³/ft. of width

1" bearing bars: Values per foot of width
 Open Space = 69%
 Approx. Weight = 2.8 lbs/sq. ft.

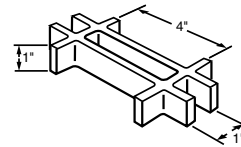

SPAN INCHES		LOAD								SAFE LOAD 5:1 SAFETY FACTOR	DEFLECTION	E x 10 ⁶ PSI
		50	100	150	200	250	300	400	500			
12	Δu	<0.010	<0.010	<0.010	0.011	0.014	0.017	0.022	0.028	1960	0.108	1.85
	Δc	<0.010	<0.010	0.013	0.018	0.022	0.027	0.035	0.044	980	0.087	
18	Δu	0.012	0.025	0.037	0.049	0.062	0.074	0.099	0.123	960	0.237	2.10
	Δc	0.013	0.026	0.039	0.053	0.066	0.079	0.105	0.131	720	0.189	
24	Δu	0.037	0.074	0.112	0.149	0.186	0.223	0.298	0.372	560	0.417	2.20
	Δc	0.030	0.060	0.089	0.119	0.149	0.179	0.238	0.298	560	0.333	
30	Δu	0.088	0.176	0.264	0.352	0.440	0.528			336	0.591	2.27
	Δc	0.056	0.113	0.169	0.225	0.282	0.338	0.451	0.563	420	0.473	
36	Δu	0.176	0.353	0.529						240	0.846	2.35
	Δc	0.094	0.188	0.282	0.376	0.470	0.564			360	0.677	
42	Δu	0.316	0.632							183	1.155	2.43
	Δc	0.144	0.289	0.433	0.577					320	0.924	

NOTE: Rectangular grating tables are for loading in the crosswise orientation.

- c IS CONCENTRATED LOAD LBS/FT OF WIDTH
- Δc IS DEFLECTION UNDER CONCENTRATED LOAD(in)
- u IS UNIFORM LOAD LBS/FT²
- Δu IS DEFLECTION UNDER UNIFORM LOAD(in)

NOTE: ALL TABLE VALUES ARE TYPICAL

Uniform Load

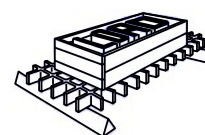

Concentrated Load

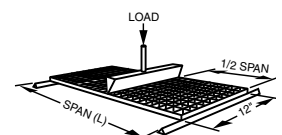

Load Tables

1-1/2" THICK 1-1/2" SQUARE MESH DURAGRATE®

A=2.85 in.²/ft. of width
 l=0.51 in.⁴/ft. of width
 S=0.65 in.³/ft. of width

1-1/2" bearing bars: Values per foot of width
 Open Space = 70%
 Approx. Weight = 3.8 lbs/sq.ft.

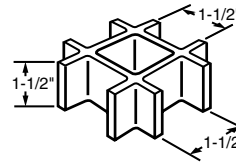

SPAN INCHES		LOAD								SAFE LOAD 5:1 SAFETY FACTOR	DEFLECTION	E x 10 ⁶ PSI
		50	100	150	200	250	300	400	500			
12	Δu	<0.010	<0.010	<0.010	<0.010	<0.010	0.011	0.014	0.018	3120	0.111	1.24
	Δc	<0.010	<0.010	<0.010	0.011	0.014	0.017	0.023	0.028	1560	0.089	
18	Δu	<0.010	0.014	0.021	0.028	0.036	0.043	0.057	0.071	1386	0.197	1.57
	Δc	<0.010	0.015	0.023	0.030	0.038	0.046	0.061	0.076	1040	0.158	
24	Δu	0.021	0.042	0.063	0.084	0.104	0.125	0.167	0.209	780	0.326	1.69
	Δc	0.017	0.033	0.050	0.067	0.084	0.100	0.134	0.167	780	0.261	
30	Δu	0.047	0.094	0.141	0.188	0.235	0.283	0.377	0.471	496	0.467	1.83
	Δc	0.030	0.060	0.090	0.121	0.151	0.181	0.241	0.301	620	0.374	
36	Δu	0.096	0.192	0.288	0.384	0.480	0.576			347	0.666	1.86
	Δc	0.051	0.102	0.154	0.205	0.256	0.307	0.410	0.512	520	0.533	
42	Δu	0.175	0.350	0.525						251	0.881	1.89
	Δc	0.080	0.160	0.240	0.320	0.400	0.480	0.641	0.801	440	0.705	
48	Δu	0.287	0.573							170	0.975	1.97
	Δc	0.115	0.229	0.344	0.459	0.573	0.688			340	0.780	

1-1/2" THICK 3/4" MINI-GRID™ DURAGRATE®

A=3.62 in.²/ft. of width
 l=0.73 in.⁴/ft. of width
 S=0.90 in.³/ft. of width

1-1/2" bearing bars: Values per foot of width
 Open Space = 44%
 Approx. Weight = 4.4 lbs/sq.ft.

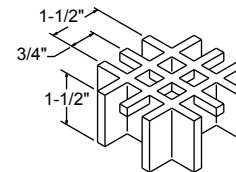

SPAN INCHES		LOAD								SAFE LOAD 5:1 SAFETY FACTOR	DEFLECTION	E x 10 ⁶ PSI
		50	100	150	200	250	300	400	500			
12	Δu	<0.010	<0.010	0.011	0.014	0.017	0.021	0.028	0.035	3860	0.270	0.44
	Δc	<0.010	0.011	0.017	0.022	0.028	0.034	0.045	0.056	1930	0.216	
18	Δu	0.013	0.026	0.039	0.052	0.065	0.078	0.104	0.130	1776	0.470	0.59
	Δc	0.014	0.028	0.042	0.056	0.070	0.084	0.112	0.139	1332	0.376	
24	Δu	0.025	0.050	0.075	0.100	0.126	0.151	0.201	0.251	1052	0.529	0.98
	Δc	0.020	0.040	0.060	0.080	0.101	0.121	0.161	0.201	1052	0.423	
30	Δu	0.055	0.110	0.165	0.219	0.274	0.329	0.439	0.548	632	0.692	1.10
	Δc	0.035	0.070	0.105	0.140	0.176	0.211	0.281	0.351	790	0.553	
36	Δu	0.087	0.173	0.260	0.346	0.433	0.520	0.692		456	0.796	1.43
	Δc	0.046	0.092	0.139	0.185	0.231	0.277	0.370	0.462	684	0.637	
42	Δu	0.150	0.300	0.450	0.600					332	1.005	1.53
	Δc	0.069	0.138	0.207	0.276					582	0.804	
48	Δu	0.245	0.490	0.735						215	1.054	1.61
	Δc	0.098	0.196	0.294						430	0.843	

Load Tables

2" THICK 2" SQUARE MESH DURAGRATE®

A=2.88 in.²/ft. of width
 I=0.96 in.⁴/ft. of width
 S=0.94 in.³/ft. of width

2" bearing bars: Values per foot of width
 Open Space = 72%
 Approx. Weight = 4.0 lbs/sq.ft.

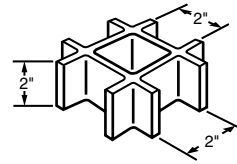

SPAN INCHES		LOAD								SAFE LOAD 5:1 SAFETY FACTOR	DEFLECTION	E x 10 ⁶ PSI
		50	100	150	200	250	300	400	500			
12	Δu	<0.010	<0.010	<0.010	<0.010	<0.010	<0.010	<0.010	0.010	4000	0.081	1.15
	Δc	<0.010	<0.010	<0.010	<0.010	<0.010	0.010	0.013	0.016	2000	0.065	
18	Δu	<0.010	<0.010	0.012	0.016	0.020	0.024	0.032	0.040	1813	0.145	1.48
	Δc	<0.010	<0.010	0.013	0.017	0.021	0.026	0.034	0.043	1360	0.116	
24	Δu	0.010	0.021	0.031	0.042	0.052	0.063	0.083	0.104	960	0.200	1.80
	Δc	<0.010	0.017	0.025	0.033	0.042	0.050	0.067	0.083	960	0.160	
30	Δu	0.023	0.046	0.069	0.092	0.114	0.137	0.183	0.229	640	0.293	2.00
	Δc	0.015	0.029	0.044	0.059	0.073	0.088	0.117	0.146	800	0.234	
36	Δu	0.044	0.089	0.133	0.177	0.222	0.266	0.355	0.444	453	0.402	2.14
	Δc	0.024	0.047	0.071	0.095	0.118	0.142	0.189	0.237	680	0.322	
42	Δu	0.082	0.164	0.245	0.327	0.409	0.491	0.654		331	0.542	2.15
	Δc	0.037	0.075	0.112	0.150	0.187	0.224	0.299	0.374	580	0.434	
48	Δu	0.135	0.270	0.405	0.541					260	0.703	2.22
	Δc	0.054	0.108	0.162	0.216	0.270	0.324	0.432	0.541	520	0.562	
54	Δu	0.210	0.420	0.630						204	0.858	2.29
	Δc	0.075	0.149	0.224	0.298	0.373	0.448	0.597		460	0.686	

1-1/2" THICK 1-1/2" x 6" RECTANGULAR DURAGRATE®

A=3.785 in.²/ft. of width
 I=0.56 in.⁴/ft. of width
 S=1.500 in.³/ft. of width

1-1/2" bearing bars: Values per foot of width
 Open Space = 67%
 Approx. Weight = 3.5 lbs/sq.ft.

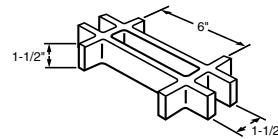

SPAN INCHES		LOAD								SAFE LOAD 5:1 SAFETY FACTOR	DEFLECTION	E x 10 ⁶ PSI
		50	100	150	200	250	300	400	500			
12	Δu	<0.010	<0.010	<0.010	<0.010	0.011	0.014	0.018	0.023	4272	0.195	0.88
	Δc	<0.010	<0.010	0.011	0.015	0.018	0.022	0.029	0.037	2136	0.156	
18	Δu	<0.010	0.018	0.027	0.035	0.044	0.053	0.071	0.089	1712	0.300	1.16
	Δc	0.010	0.019	0.028	0.038	0.047	0.057	0.076	0.095	1284	0.240	
24	Δu	0.019	0.038	0.056	0.075	0.094	0.112	0.150	0.188	956	0.359	1.71
	Δc	0.015	0.030	0.045	0.060	0.075	0.090	0.120	0.150	956	0.288	
30	Δu	0.039	0.078	0.117	0.156	0.195	0.233	0.311	0.389	587	0.458	2.01
	Δc	0.025	0.050	0.075	0.100	0.125	0.150	0.200	0.250	734	0.367	
36	Δu	0.071	0.143	0.214	0.285	0.357	0.428			385	0.550	2.28
	Δc	0.038	0.076	0.114	0.152	0.190	0.228	0.304	0.381	578	0.440	
42	Δu	0.126	0.252	0.378	0.504	0.630				370	0.680	2.39
	Δc	0.058	0.115	0.173	0.230	0.288	0.346	0.461		472	0.544	
48	Δu	0.207	0.414	0.621						184	0.760	2.49
	Δc	0.083	0.160	0.248	0.331	0.414	0.497			368	0.608	



STRONGWELL

ISO-9001:2000 Certified Manufacturing Plants

BRISTOL DIVISION

400 Commonwealth Ave., Bristol, VA 24201-3820 USA
(276)645-8000 FAX (276)645-8132

CHATFIELD DIVISION

1610 Highway 52 South, Chatfield, MN 55923-9799 USA
(507)867-3479 FAX (507)867-4031

www.strongwell.com

INT5M0409
©Strongwell